

## ADM488/ADM489

### FEATURES

- Meets EIA RS-485 Standard
- 250 kbps Data Rate
- Single +5 V  $\pm$  10% Supply
- 7 V to +12 V Bus Common-Mode Range
- 12 k $\Omega$  Input Impedance
- 2 kV EFT Protection Meets IEC1000-4-4
- High EM Immunity Meets IEC1000-4-3
- Reduced Slew Rate for Low EM Interference
- Short Circuit Protection
- Excellent Noise Immunity
- 30  $\mu$ A Supply Current

### APPLICATIONS

- Low Power RS-485 Systems
- DTE-DCE Interface
- Packet Switching
- Local Area Networks
- Data Concentration
- Data Multiplexers
- Integrated Services Digital Network (ISDN)

### GENERAL DESCRIPTION

The ADM488 and ADM489 are low power differential line transceiver suitable for communication on multipoint bus transmission lines.

They are intended for balanced data transmission and comply with both EIA Standards RS-485 and RS-422. Both products contains a single differential line driver and a single differential line receiver making them suitable for full duplex data transfer.

The ADM489 contains an additional receiver and driver enable control.

The input impedance is 12 k $\Omega$ , allowing 32 transceivers to be connected on the bus.

The ADM488/ADM489 operates from a single +5 V  $\pm$  10% power supply. Excessive power dissipation caused by bus contention or by output shorting is prevented by a thermal shut-down circuit. This feature forces the driver output into a high impedance state if during fault conditions a significant temperature increase is detected in the internal driver circuitry.

### FUNCTIONAL BLOCK DIAGRAMS

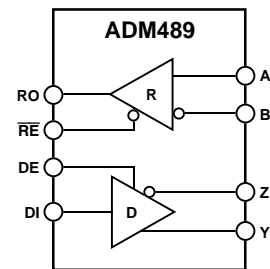
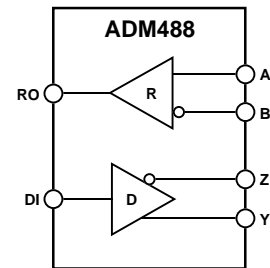

The receiver contains a fail-safe feature that results in a logic high output state if the inputs are unconnected (floating).

The ADM488/ADM489 is fabricated on BiCMOS, an advanced mixed technology process combining low power CMOS with fast switching bipolar technology.

The ADM488/ADM489 is fully specified over the industrial temperature range and is available in DIP, SOIC and TSSOP packages.

REV. 0

Information furnished by Analog Devices is believed to be accurate and reliable. However, no responsibility is assumed by Analog Devices for its use, nor for any infringements of patents or other rights of third parties which may result from its use. No license is granted by implication or otherwise under any patent or patent rights of Analog Devices.

# ADM488/ADM489–SPECIFICATIONS

( $V_{CC} = +5\text{ V} \pm 10\%$ . All specifications  $T_{MIN}$  to  $T_{MAX}$  unless otherwise noted)

| Parameter  | Min  | Typ | Max       | Units         | Test Conditions/Comments   |
|--|------|-----|-----------|---------------|--|
| <b>DRIVER</b>  |      |     |           |               |  |
| Differential Output Voltage, $V_{OD}$                    |      |     | 5.0       | V             | $R = \infty$ , Figure 1  |
|  | 2.0  |     | 5.0       | V             | $V_{CC} = 5\text{ V}$ , $R = 50\ \Omega$ (RS-422), Figure 1                        |
|  | 1.5  |     | 5.0       | V             | $R = 27\ \Omega$ (RS-485), Figure 1  |
|  | 1.5  |     | 5.0       | V             | $V_{TST} = -7\text{ V to } +12\text{ V}$ , Figure 2, $V_{CC} = 5\text{ V} \pm 5\%$ |
| $\Delta V_{OD} $ for Complementary Output States         |      |     | 0.2       | V             | $R = 27\ \Omega$ or $50\ \Omega$ , Figure 1  |
| Common-Mode Output Voltage $V_{OC}$                      |      |     | 3         | V             | $R = 27\ \Omega$ or $50\ \Omega$ , Figure 1  |
| $\Delta V_{OC} $ for Complementary Output States         |      |     | 0.2       | V             | $R = 27\ \Omega$ or $50\ \Omega$   |
| Output Short Circuit Current ( $V_{OUT} = \text{High}$ ) |      |     | 250       | mA            | $-7\text{ V} \leq V_O \leq +12\text{ V}$   |
| Output Short Circuit Current ( $V_{OUT} = \text{Low}$ )  |      |     | 250       | mA            | $-7\text{ V} \leq V_O \leq +12\text{ V}$   |
| CMOS Input Logic Threshold Low, $V_{INL}$                |      | 1.4 | 0.8       | V             |  |
| CMOS Input Logic Threshold High, $V_{INH}$               | 2.0  | 1.4 |           | V             |  |
| Logic Input Current (DE, DI)                             |      |     | $\pm 1.0$ | $\mu\text{A}$ |  |
| <b>RECEIVER</b>  |      |     |           |               |  |
| Differential Input Threshold Voltage, $V_{TH}$           | -0.2 |     | +0.2      | V             | $-7\text{ V} \leq V_{CM} \leq +12\text{ V}$  |
| Input Voltage Hysteresis, $\Delta V_{TH}$                |      | 70  |           | mV            | $V_{CM} = 0\text{ V}$  |
| Input Resistance   | 12   |     |           | k $\Omega$    | $-7\text{ V} \leq V_{CM} \leq +12\text{ V}$  |
| Input Current (A, B)                                     |      |     | +1        | mA            | $V_{IN} = 12\text{ V}$   |
|  |      |     | -0.8      | mA            | $V_{IN} = -7\text{ V}$   |
| Logic Enable Input Current ( $\overline{\text{RE}}$ )    |      |     | $\pm 1$   | $\mu\text{A}$ |  |
| CMOS Output Voltage Low, $V_{OL}$                        |      |     | 0.4       | V             | $I_{OUT} = +4.0\text{ mA}$   |
| CMOS Output Voltage High, $V_{OH}$                       | 4.0  |     |           | V             | $I_{OUT} = -4.0\text{ mA}$   |
| Short Circuit Output Current                             | 7    |     | 85        | mA            | $V_{OUT} = \text{GND or } V_{CC}$  |
| Three-State Output Leakage Current                       |      |     | $\pm 1.0$ | $\mu\text{A}$ | $0.4\text{ V} \leq V_{OUT} \leq +2.4\text{ V}$                                     |
| <b>POWER SUPPLY CURRENT</b>                              |      |     |           |               |  |
| $I_{CC}$   |      | 30  | 60        | $\mu\text{A}$ | Outputs Unloaded, Receivers Enabled  |
|  |      | 37  | 74        | $\mu\text{A}$ | DE = 0 V (Disabled)  |
|  |      |     |           |               | DE = 5 V (Enabled)   |

Specifications subject to change without notice.

## TIMING SPECIFICATIONS ( $V_{CC} = +5\text{ V} \pm 10\%$ . All specifications $T_{MIN}$ to $T_{MAX}$ unless otherwise noted)

| Parameter   | Min | Typ | Max  | Units | Test Conditions/Comments   |
|---|-----|-----|------|-------|--|
| <b>DRIVER</b>   |     |     |      |       |  |
| Propagation Delay Input to Output $T_{PLH}$ , $T_{PHL}$ | 250 |     | 2000 | ns    | $R_L \text{ Diff} = 54\ \Omega$ , $C_{L1} = C_{L2} = 100\text{ pF}$ , Figure 5 |
| Driver O/P to $\overline{\text{O/P}}$ $T_{SKEW}$        |     | 100 | 800  | ns    | $R_L \text{ Diff} = 54\ \Omega$ , $C_{L1} = C_{L2} = 100\text{ pF}$ , Figure 5 |
| Driver Rise/Fall Time $T_R$ , $T_F$                     | 250 |     | 2000 | ns    | $R_L \text{ Diff} = 54\ \Omega$ , $C_{L1} = C_{L2} = 100\text{ pF}$ , Figure 5 |
| Driver Enable to Output Valid                           | 250 |     | 2000 | ns    | $R_L = 500\ \Omega$ , $C_L = 100\text{ pF}$ , Figure 2                         |
| Driver Disable Timing                                   | 300 |     | 3000 | ns    | $R_L = 500\ \Omega$ , $C_L = 15\text{ pF}$ , Figure 2                          |
| Data Rate   | 250 |     |      | kbps  |  |
| <b>RECEIVER</b>   |     |     |      |       |  |
| Propagation Delay Input to Output $T_{PLH}$ , $T_{PHL}$ | 250 |     | 2000 | ns    | $C_L = 15\text{ pF}$ , Figure 5  |
| Skew $ T_{PLH} - T_{PHL} $                              |     | 100 |      | ns    |  |
| Receiver Enable $T_{EN1}$                               |     | 10  | 50   | ns    | $R_L = 1\text{ k}\Omega$ , $C_L = 15\text{ pF}$ , Figure 4                     |
| Receiver Disable $T_{EN2}$                              |     | 10  | 50   | ns    | $R_L = 1\text{ k}\Omega$ , $C_L = 15\text{ pF}$ , Figure 4                     |
| Data Rate   | 250 |     |      | kbps  |  |

Specifications subject to change without notice.

## ABSOLUTE MAXIMUM RATINGS\*

( $T_A = +25^\circ\text{C}$  unless otherwise noted)

|   |                            |
|---|----------------------------|
| $V_{CC}$ .....                              | +7 V                       |
| <b>Inputs</b>                               |                            |
| Driver Input (DI) .....                     | -0.3 V to $V_{CC} + 0.3$ V |
| Control Inputs (DE, $\overline{RE}$ ) ..... | -0.3 V to $V_{CC} + 0.3$ V |
| Receiver Inputs (A, B) .....                | -14 V to +14 V             |
| <b>Outputs</b>                              |                            |
| Driver Outputs .....                        | -14 V to +12.5 V           |
| Receiver Output .....                       | -0.5 V to $V_{CC} + 0.5$ V |
| Power Dissipation 8-Lead DIP .....          | 700 mW                     |
| $\theta_{JA}$ , Thermal Impedance .....     | 120°C/W                    |
| Power Dissipation 8-Lead SOIC .....         | 520 mW                     |
| $\theta_{JA}$ , Thermal Impedance .....     | 110°C/W                    |
| Power Dissipation 14-Lead DIP .....         | 800 mW                     |
| $\theta_{JA}$ , Thermal Impedance .....     | 140°C/W                    |
| Power Dissipation 14-Lead SOIC .....        | 800 mW                     |
| $\theta_{JA}$ , Thermal Impedance .....     | 120°C/W                    |

|   |                 |
|---|-----------------|
| Power Dissipation 16-Lead TSSOP .....       | 800 mW          |
| $\theta_{JA}$ , Thermal Impedance .....     | 150°C/W         |
| <b>Operating Temperature Range</b>          |                 |
| Industrial (A Version) .....                | -40°C to +85°C  |
| Storage Temperature Range .....             | -65°C to +150°C |
| Lead Temperature (Soldering, 10 secs) ..... | +300°C          |
| Vapor Phase (60 secs) .....                 | +215°C          |
| Infrared (15 secs) .....                    | +220°C          |
| ESD Rating, MIL-STD-883B .....              | 4 kV            |
| EFT Rating, IEC1000-4-4 .....               | 2 kV            |

\*Stresses above those listed under Absolute Maximum Ratings may cause permanent damage to the device. This is a stress rating only; functional operation of the device at these or any other conditions above those listed in the operational sections of this specification is not implied. Exposure to absolute maximum ratings for extended periods of time may affect device reliability.

## ORDERING GUIDE

| Model     | Temperature Range | Package Description                               | Package Option |
|-----------|-------------------|---|----------------|
| ADM488AR  | -40°C to +85°C    | 8-Lead Narrow Body (SOIC)                         | SO-8           |
| ADM488AN  | -40°C to +85°C    | 8-Lead Plastic DIP                                | N-8            |
| ADM489AN  | -40°C to +85°C    | 14-Lead Plastic DIP (Narrow)                      | N-14           |
| ADM489AR  | -40°C to +85°C    | 14-Lead Narrow Body (SOIC)                        | R-14           |
| ADM489ARU | -40°C to +85°C    | 16-Lead Thin Shrink Small Outline Package (TSSOP) | RU-16          |

# ADM488/ADM489

## ADM488 PIN FUNCTION DESCRIPTIONS

| Pin | Mnemonic        | Function  |
|-----|-----------------|---|
| 1   | V <sub>CC</sub> | Power Supply, 5 V ± 10%.  |
| 2   | RO              | Receiver Output. When A > B by 200 mV, RO = high. If A < B by 200 mV, RO = low.                           |
| 3   | DI              | Driver Input. A logic Low on DI forces Y low and Z high while a logic High on DI forces Y high and Z low. |
| 4   | GND             | Ground Connection, 0 V  |
| 5   | Y               | Noninverting Driver, Output Y   |
| 6   | Z               | Inverting Driver, Output Z  |
| 7   | B               | Inverting Receiver Input B  |
| 8   | A               | Noninverting Receiver Input A   |

## ADM489 PIN FUNCTION DESCRIPTIONS

| DIP/SOIC Pin | TSSOP Pin        | Mnemonic        | Function   |
|--------------|------------------|-----------------|--|
| 1, 8, 13     | 2, 9, 10, 13, 16 | NC              | No Connect. No connections are required to this pin.   |
| 2            | 3                | RO              | Receiver Output. When enabled if A > B by 200 mV then RO = high. If A < B by 200 mV then RO = low.                                     |
| 3            | 4                | $\overline{RE}$ | Receiver Output Enable. A low level enables the receiver output, RO. A high level places it in a high impedance state.                 |
| 4            | 5                | DE              | Driver Output Enable. A high level enables the driver differential outputs, Y and Z. A low level places it in a high impedance state.  |
| 5            | 6                | DI              | Driver Input. When the driver is enabled, a logic Low on DI forces Y low and Z high, while a logic High on DI forces Y high and Z low. |
| 6, 7         | 7, 8             | GND             | Ground Connection, 0 V   |
| 9            | 11               | Y               | Noninverting Driver Output Y   |
| 10           | 12               | Z               | Inverting Driver Output Z  |
| 11           | 14               | B               | Inverting Receiver Input B   |
| 12           | 15               | A               | Noninverting Receiver Input A  |
| 14           | 1                | V <sub>CC</sub> | Power Supply, 5 V ± 10%.   |

## PIN CONFIGURATIONS

### 8-Lead DIP/SO

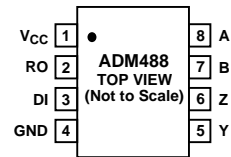

### 14-Lead DIP/SO

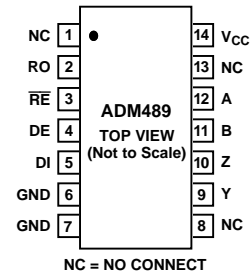

### 16-Lead TSSOP

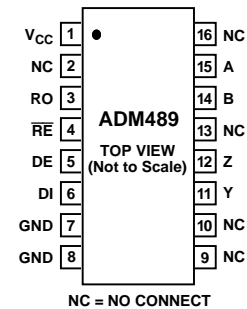

# Test Circuits

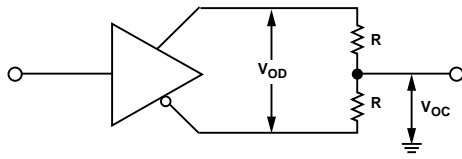

Figure 1. Driver Voltage Measurement Test Circuit

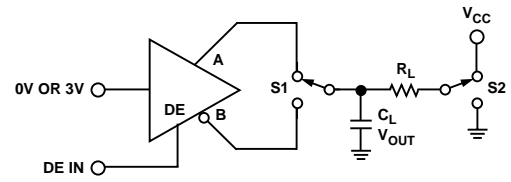

Figure 3. Driver Voltage Measurement Test Circuit 2

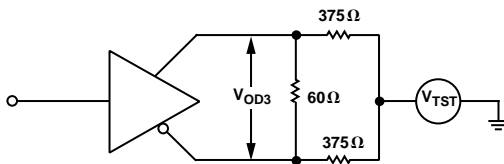

Figure 2. Driver Enable/Disable Test Circuit

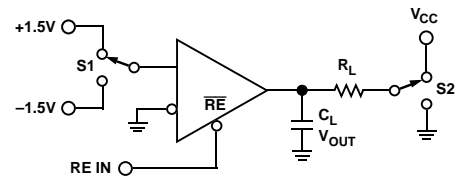

Figure 4. Receiver Enable/Disable Test Circuit

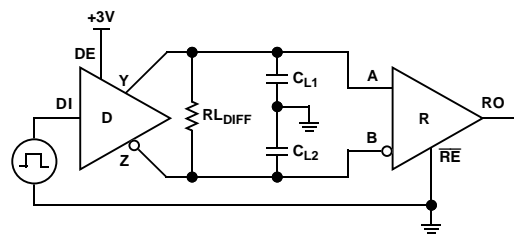

Figure 5. Driver/Receiver Propagation Delay Test Circuit

# ADM488/ADM489

## Switching Characteristics

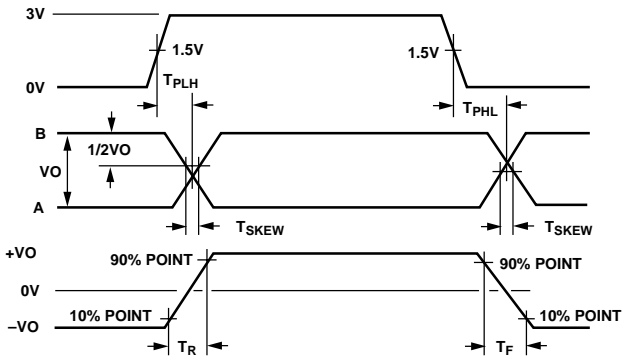

Figure 6. Driver Propagation Delay, Rise/Fall Timing

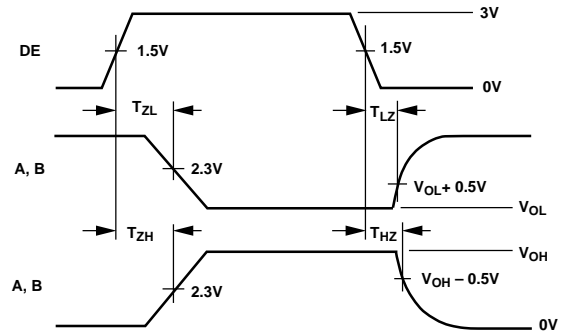

Figure 8. Driver Enable/Disable Timing

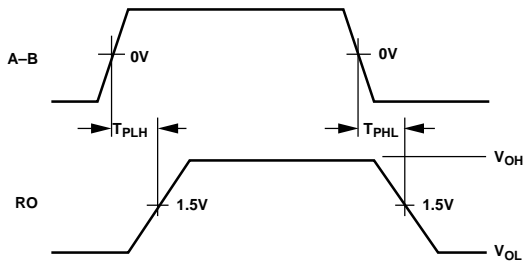

Figure 7. Receiver Propagation Delay

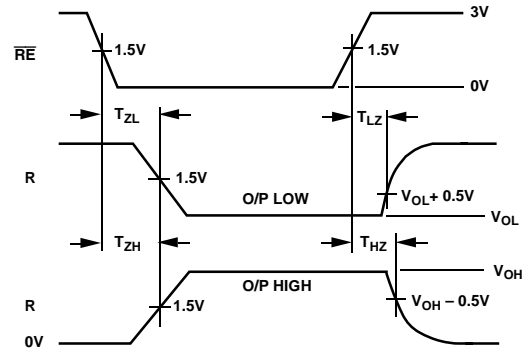

Figure 9. Receiver Enable/Disable Timing

# Typical Performance Characteristics–ADM488/ADM489

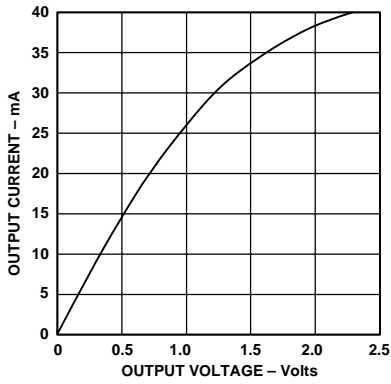

Figure 10. Receiver Output Low Voltage vs. Output Current

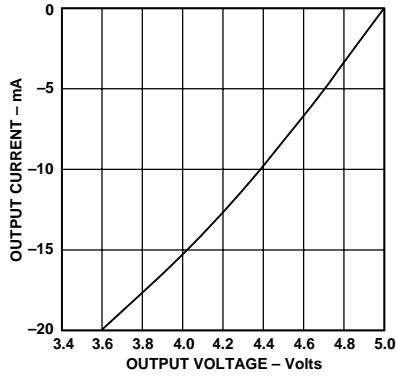

Figure 11. Receiver Output High Voltage vs. Output Current

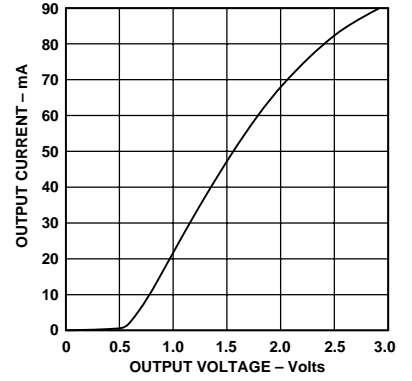

Figure 12. Driver Output Low Voltage vs. Output Current

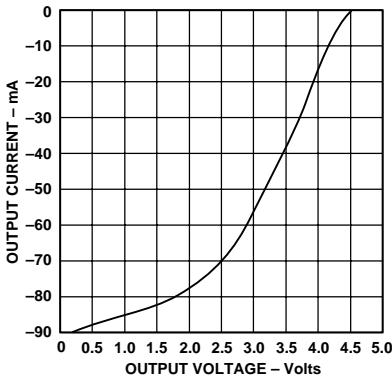

Figure 13. Driver Output High Voltage vs. Output Current

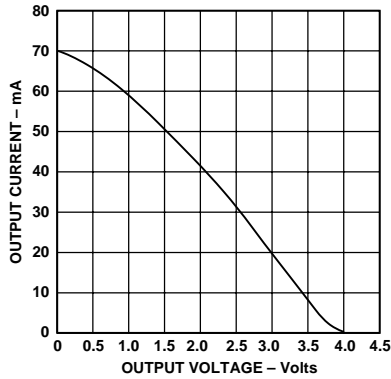

Figure 14. Driver Differential Output Voltage vs. Output Current

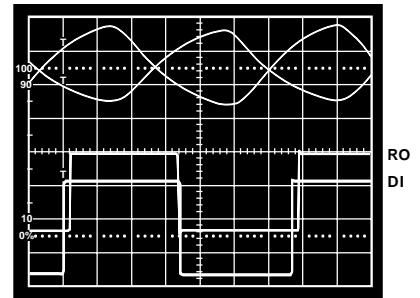

Figure 15. Driving 4000 ft. of Cable

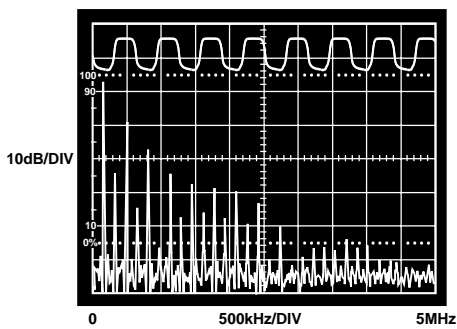

Figure 16. Driver Output Waveform and FFT Plot Transmitting @ 150 kHz

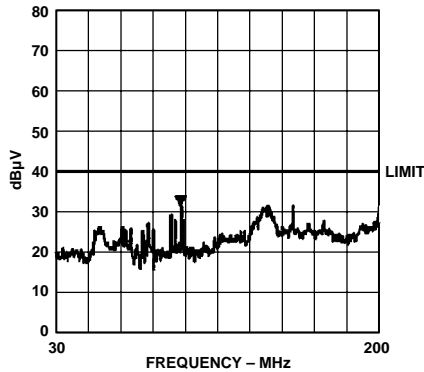

Figure 17. Radiated Emissions

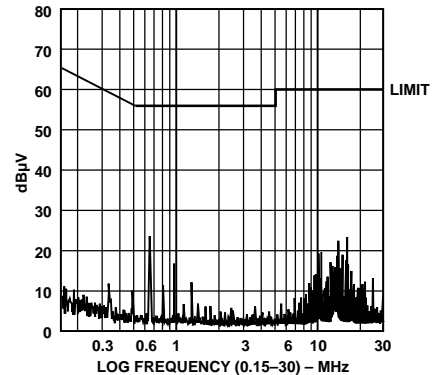

Figure 18. Conducted Emissions

# ADM488/ADM489

## GENERAL INFORMATION

The ADM488/ADM489 is a ruggedized RS-485 transceiver that operates from a single +5 V supply.

It contains protection against radiated and conducted interference.

It is ideally suited for operation in electrically harsh environments or where cables may be plugged/unplugged. It is also immune to high RF field strengths without special shielding precautions. It is intended for balanced data transmission and complies with both EIA Standards RS-485 and RS-422. It contains a differential line driver and a differential line receiver, and is suitable for full duplex data transmission.

The input impedance on the ADM488/ADM489 is 12 kΩ, allowing up to 32 transceivers on the differential bus.

The ADM488/ADM489 operates from a single +5 V ± 10% power supply. Excessive power dissipation caused by bus contention or by output shorting is prevented by a thermal shutdown circuit. This feature forces the driver output into a high impedance state if, during fault conditions, a significant temperature increase is detected in the internal driver circuitry.

The receiver contains a fail-safe feature that results in a logic high output state if the inputs are unconnected (floating).

A high level of robustness is achieved using internal protection circuitry, eliminating the need for external protection components such as tranzorbs or surge suppressors.

Low electromagnetic emissions are achieved using slew limited drivers, minimizing interference both conducted and radiated.

The ADM488/ADM489 can transmit at data rates up to 250 kbps.

A typical application for the ADM488/ADM489 is illustrated in Figure 19. This shows a full-duplex link where data may be transferred at rates up to 250 kbps. A terminating resistor is shown at both ends of the link. This termination is not critical since the slew rate is controlled by the ADM488/ADM489 and reflections are minimized.

The communications network may be extended to include multipoint connections as shown in Figure 25. Up to 32 transceivers may be connected to the bus.

Tables I and II show the truth tables for transmitting and receiving.

**Table I. Transmitting Truth Table**

| $\overline{RE}$ | Inputs |    | Outputs |      |
|-----------------|--------|----|---------|------|
|                 | DE     | DI | Z       | Y    |
| X               | 1      | 1  | 0       | 1    |
| X               | 1      | 0  | 1       | 0    |
| 0               | 0      | X  | Hi-Z    | Hi-Z |
| 1               | 0      | X  | Hi-Z    | Hi-Z |

X = Don't Care.

**Table II. Receiving Truth Table**

| $\overline{RE}$ | Inputs |               | Output |
|-----------------|--------|---------------|--------|
|                 | DE     | A-B           | RO     |
| 0               | 0      | $\geq +0.2$ V | 1      |
| 0               | 1      | $\leq +0.2$ V | 0      |
| 0               | 0      | Inputs O/C    | 1      |
| 1               | 0      | X             | Hi-Z   |

X = Don't Care.

## EFT TRANSIENT PROTECTION SCHEME

The ADM488/ADM489 uses protective clamping structures on its inputs and outputs that clamp the voltage to a safe level and dissipates the energy present in ESD (Electrostatic) and EFT (Electrical Fast Transients) discharges.

## FAST TRANSIENT BURST IMMUNITY (IEC1000-4-4)

IEC1000-4-4 (previously 801-4) covers electrical fast-transient/burst (EFT) immunity. Electrical fast transients occur as a result of arcing contacts in switches and relays. The tests simulate the interference generated when, for example, a power relay disconnects an inductive load. A spark is generated due to the well known back EMF effect. In fact, the spark consists of a burst of sparks as the relay contacts separate. The voltage appearing on the line, therefore, consists of a burst of extremely fast transient impulses. A similar effect occurs when switching on fluorescent lights.

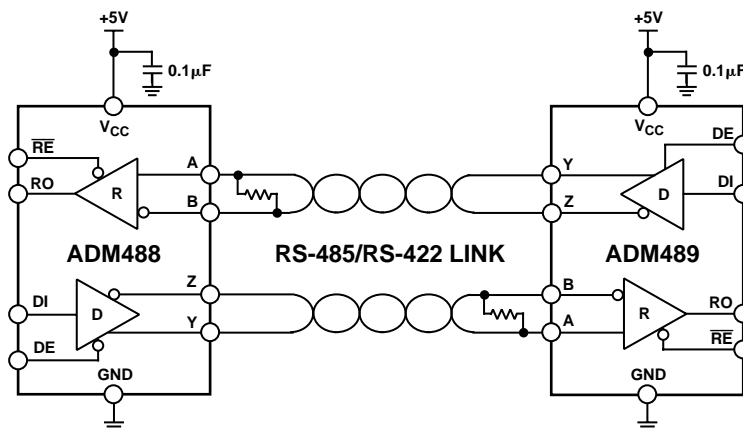

Figure 19. ADM488/ADM489 Full-Duplex Data Link



The fast transient burst test, defined in IEC1000-4-4, simulates this arcing and its waveform is illustrated in Figure 20. It consists of a burst of 2.5 kHz to 5 kHz transients repeating at 300 ms intervals. It is specified for both power and data lines.

Four severity levels are defined in terms of an open-circuit voltage as a function of installation environment. The installation environments are defined as

1. Well-protected
2. Protected
3. Typical Industrial
4. Severe Industrial

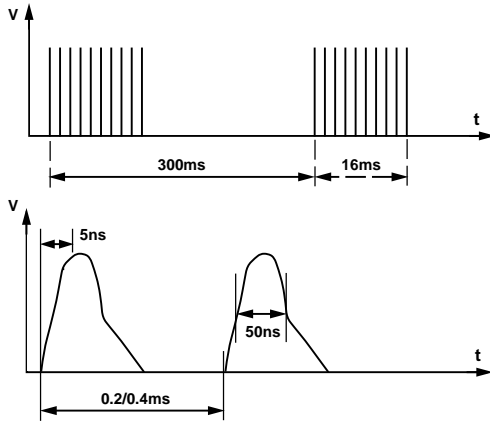

Figure 20. IEC1000-4-4 Fast Transient Waveform

Table III shows the peak voltages for each of the environments.

Table III.

| Level | V <sub>PEAK</sub> (kV) PSU | V <sub>PEAK</sub> (kV) I-O |
|-------|----------------------------|----------------------------|
| 1     | 0.5                        | 0.25                       |
| 2     | 1                          | 0.5                        |
| 3     | 2                          | 1                          |
| 4     | 4                          | 2                          |

A simplified circuit diagram of the actual EFT generator is illustrated in Figure 21.

These transients are coupled onto the signal lines using an EFT coupling clamp. The clamp is 1 m long and completely surrounds the cable, providing maximum coupling capacitance (50 pF to 200 pF typ) between the clamp and the cable. High energy transients are capacitively coupled onto the signal lines. Fast rise times (5 ns) as specified by the standard result in very effective coupling. This test is very severe since high voltages are coupled onto the signal lines. The repetitive transients can often cause problems, where single pulses do not. Destructive latchup may be induced due to the high energy content of the transients. Note that this stress is applied while the interface products are powered up and are transmitting data. The EFT test applies hundreds of pulses with higher energy than ESD. Worst case transient current on an I-O line can be as high as 40 A.

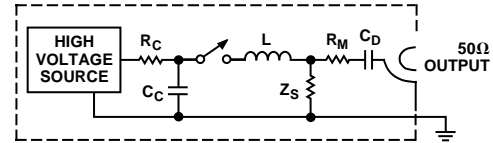

Figure 21. EFT Generator

Test results are classified according to the following:

1. Normal performance within specification limits.
2. Temporary degradation or loss of performance that is self-recoverable.
3. Temporary degradation or loss of function or performance that requires operator intervention or system reset.
4. Degradation or loss of function that is not recoverable due to damage.

The ADM488/ADM489 has been tested under worst case conditions using unshielded cables, and meets Classification 2 at severity Level 4. Data transmission during the transient condition is corrupted, but it may be resumed immediately following the EFT event without user intervention.

**RADIATED IMMUNITY (IEC1000-4-3)**

IEC1000-4-3 (previously IEC801-3) describes the measurement method and defines the levels of immunity to radiated electromagnetic fields. It was originally intended to simulate the electromagnetic fields generated by portable radio transceivers or any other device that generates continuous wave radiated electromagnetic energy. Its scope has since been broadened to include spurious EM energy, which can be radiated from fluorescent lights, thyristor drives, inductive loads, etc.

Testing for immunity involves irradiating the device with an EM field. There are various methods of achieving this including use of anechoic chamber, stripline cell, TEM cell and GTEM cell. These consist essentially of two parallel plates with an electric field developed between them. The device under test is placed between the plates and exposed to the electric field. There are three severity levels having field strengths ranging from 1 V to 10 V/m. Results are classified as follows:

1. Normal Operation.
2. Temporary Degradation or loss of function that is self-recoverable when the interfering signal is removed.
3. Temporary degradation or loss of function that requires operator intervention or system reset when the interfering signal is removed.
4. Degradation or loss of function that is not recoverable due to damage.

# ADM488/ADM489

The ADM488/ADM489 comfortably meets Classification 1 at the most stringent (Level 3) requirement. In fact, field strengths up to 30 V/m showed no performance degradation and error-free data transmission continued even during irradiation.

**Table IV.**

| Level<br>V/m | Field Strength |
|--------------|----------------|
| 1            | 1              |
| 2            | 3              |
| 3            | 10             |

## EMI EMISSIONS

The ADM488/ADM489 contains internal slew rate limiting in order to minimize the level of electromagnetic interference generated. Figure 22 shows an FFT plot when transmitting a 150 kHz data stream.

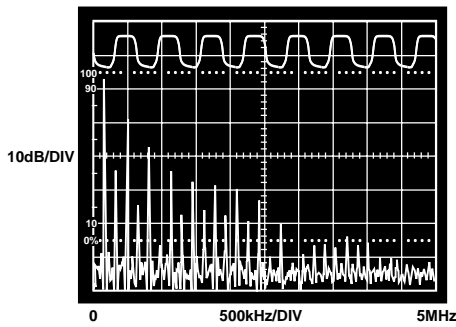

Figure 22. Driver Output Waveform and FFT Plot Transmitting @ 150 kHz

As may be seen, the slew limiting attenuates the high frequency components. EMI is therefore reduced, as are reflections due to improperly terminated cables.

EN55022, CISPR22 defines the permitted limits of radiated and conducted interference from Information Technology Equipment (ITE).

The objective is to control the level of emissions, both conducted and radiated.

For ease of measurement and analysis, conducted emissions are assumed to predominate below 30 MHz, while radiated emissions predominate above this frequency.

## CONDUCTED EMISSIONS

This is a measure of noise that is conducted onto the mains power supply. The noise is measured using a LISN (Line Impedance Stabilizing Network) and a spectrum analyzer. The test setup is illustrated in Figure 23. The spectrum analyzer is set to scan the spectrum from 0 MHz to 30 MHz. Figure 24 shows that the level of conducted emissions from the ADM488/ADM489 are well below the allowable limits.

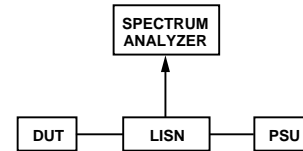

Figure 23. Conducted Emissions Test Setup

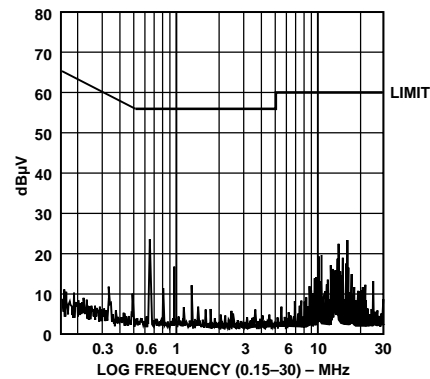

Figure 24. Conducted Emissions

**APPLICATIONS INFORMATION**

**Differential Data Transmission**

Differential data transmission is used to reliably transmit data at high rates over long distances and through noisy environments. Differential transmission nullifies the effects of ground shifts and noise signals, which appear as common-mode voltages on the line. Two main standards are approved by the Electronics Industries Association (EIA), which specify the electrical characteristics of transceivers used in differential data transmission.

The RS-422 standard specifies data rates up to 10 MBaud and line lengths up to 4000 ft. A single driver can drive a transmission line with up to 10 receivers.

In order to cater to true multipoint communications, the RS-485 standard was defined. This standard meets or exceeds all the requirements of RS-422 and also allows for up to 32 drivers and 32 receivers to be connected to a single bus. An extended common-mode range of -7 V to +12 V is defined. The most significant difference between RS-422 and RS-485 is the fact that the drivers may be disabled thereby allowing more than one (32, in fact) to be connected to a single line. Only one driver should be enabled at a time but the RS-485 standard contains additional specifications to guarantee device safety in the event of line contention.

**Cable and Data Rate**

The transmission line of choice for RS-485 communications is a twisted pair. Twisted pair cable tends to cancel common mode noise and also causes cancellation of the magnetic fields generated by the current flowing through each wire, thereby reducing the effective inductance of the pair.

The ADM488/ADM489 is designed for bidirectional data communications on multipoint transmission lines. A typical application showing a multipoint transmission network is illustrated in Figure 25. An RS-485 transmission line can have as many as 32 transceivers on the bus. Only one driver can transmit at a particular time but multiple receivers may simultaneously be enabled.

As with any transmission line, it is important that reflections are minimized. This may be achieved by terminating the extreme ends of the line using resistors equal to the characteristic impedance of the line. Stub lengths of the main line should also be kept as short as possible. A properly terminated transmission line appears purely resistive to the driver.

**Table V. Comparison of RS-422 and RS-485 Interface Standards**

| Specification                        | RS-422       | RS-485        |
|--------------------------------------|--------------|---------------|
| Transmission Type                    | Differential | Differential  |
| Maximum Data Rate                    | 10 MB/s      | 10 MB/s       |
| Maximum Cable Length                 | 4000 ft.     | 4000 ft.      |
| Minimum Driver Output Voltage        | ±2 V         | ±1.5 V        |
| Driver Load Impedance                | 100 Ω        | 54 Ω          |
| Receiver Input Resistance            | 4 kΩ min     | 12 kΩ min     |
| Receiver Input Sensitivity           | ±200 mV      | ±200 mV       |
| Receiver Input Voltage Range         | -7 V to +7 V | -7 V to +12 V |
| Number of Drivers/Receivers Per Line | 1/10         | 32/32         |

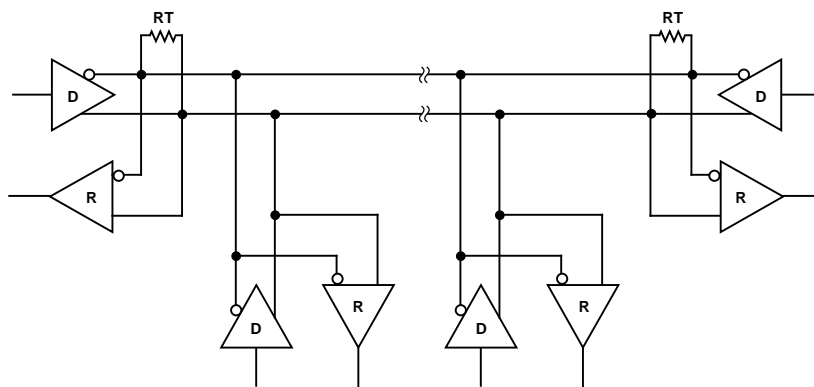
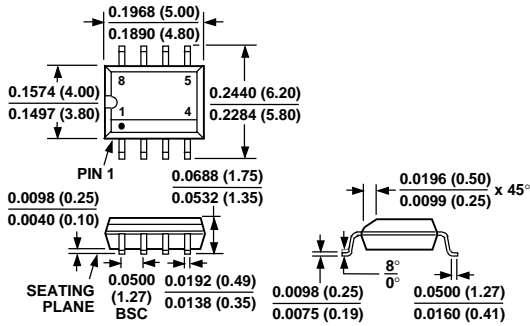

Figure 25. Typical RS-485 Network

**OUTLINE DIMENSIONS**  
Dimensions shown in inches and (mm).

**8-Lead Narrow Body (SOIC)  
(SO-8)**



**14-Lead Plastic DIP  
(N-14)**

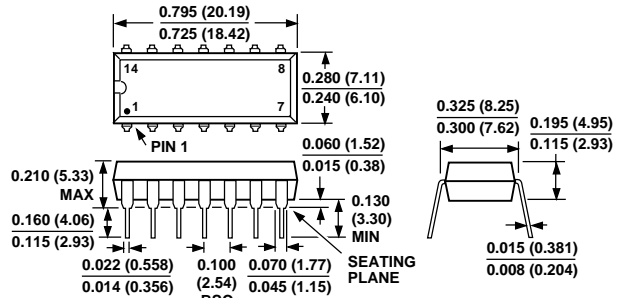

**8-Lead Plastic DIP  
(N-8)**

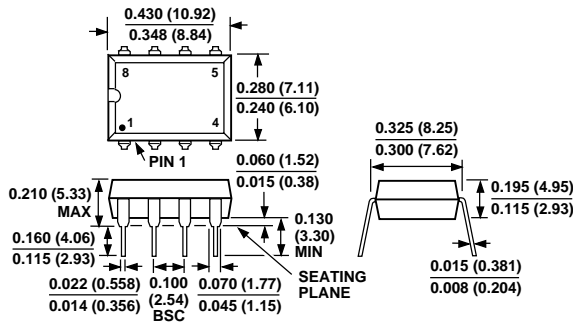

**14-Lead Narrow Body (SOIC)  
(R-14)**

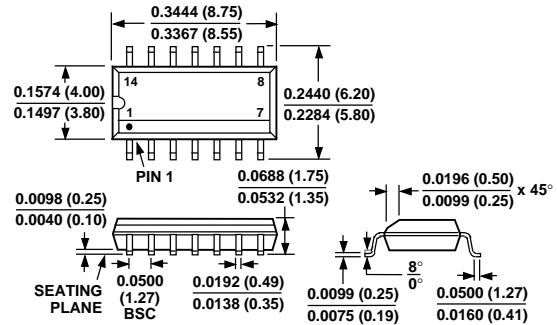

**16-Lead Thin Shrink Small Outline Package (TSSOP)  
(RU-16)**

